

GRIMMEN

HARMONY WITH FUTURE

PRO ESPRESSO MACHINE

GR-EMS503

HOUSEHOLD USE ONLY

Please read all instructions carefully before using the product

IMPORTANT SAFEGUARDS

Before using this appliance, the following basic precautions should always be followed:

1. Read all instructions
2. Before using, check that the voltage of the wall outlet corresponds to the voltage marked on the rating plate.
3. This appliance comes with a grounded plug
4. To protect against fire, electric shock, and injury do not immerse the cord or plug in water or other liquids.
5. Remove plug from wall outlet before cleaning and when not in use. Allow appliance to cool down completely before taking off or attaching components or before cleaning.
6. Do not operate any appliance with a damaged cord or plug or after the appliance malfunctions, or is dropped or damaged in any manner. Return appliance to the nearest authorized service facility for examination, repairs or adjustments.
7. The use of accessory attachments not recommended by the appliance manufacturer may result in fire, electric shock or injury.
8. Place appliance on a flat surface or table, Do not hang power cord over the edge of table or counter.
9. Ensure the power cord does not touch the hot surface of the

appliance.

10. Do not place the coffee maker on a hot surface or beside an open flame.

11. To disconnect, turn to " off ", then remove the plug from wall outlet. Always hold the plug. But never pull the cord.

12. Do not use appliance for other than intended use.

13. Close supervision is necessary when appliance is being used by or near children.

14. Be careful not to get burned by the steam.

15. Do not touch any hot surface of the appliance (including the steam wand, and the steel mesh). Use handle or knobs.

16. Do not let the coffee maker operate without water.

17. Scalding may occur if the water tank is removed during the brewing cycle.

18. Do not remove the filter holder when in use or when steam or hot water escape from the holder.

19. Release pressure through the steam wand before removing water tank cover or filter holder.

20. This appliance is not intended for use by persons (including children) with reduced physical, sensory or mental capabilities, or lack of experience and knowledge, unless they have been given supervision or instruction concerning use of the appliance by a person responsible for their safety.

21. Children should be supervised to ensure that they do not play with the appliance.

22. This appliance is intended to be used in household and similar applications such as:

- staff kitchen areas in shops, offices and other working environments;
- farm houses;
- bed and breakfast type environments.

Do not use outdoors.

Do not place on or near a hot gas or electric burner, or in a heated oven.

SAVE THESE INSTRUCTIONS

NOTE REGARDING THE PLUG

This appliance has a polarized plug (one blade is wider than the other). To reduce the risk of electric shock, this plug is intended to fit into a polarized outlet only one way. If the plug does not fit fully into the outlet, reverse the plug. If it still does not fit, contact a qualified electrician. Do not attempt to modify the plug in any way.

NOTE REGARDING THE CORD

1. A short power-supply cord (or detachable power-supply cord) is provided to reduce the risk of becoming entangled in or tripping over a longer cord.

2. Longer detachable power-supply cords or extension cords are available and may be used if care is exercised in their use.

3. If a longer detachable power-supply cord or extension cord is used:

- The marked electrical rating of the cord or extension cord should be at least as great as the electrical rating of the appliance;
- The cord should be arranged so that it will not drape over the counter top or tabletop where it can be pulled on by children or tripped over unintentionally;
- If the appliance is of the grounded type, the cord or extension cord should be a grounding-type 3-wire cord.

SPECIFICATION:

Model: GR-EMS503

Voltage: 220-240 ~ 50/60Hz

Power: 1400W

Capacity of Water Tank:1.2L

Accessories: Single Filter *1, Double Filter *1,
Portfilter *1, Coffee Spoon *1

KNOW YOUR COFFEE MAKER

(Product may be subject to change without prior notice)

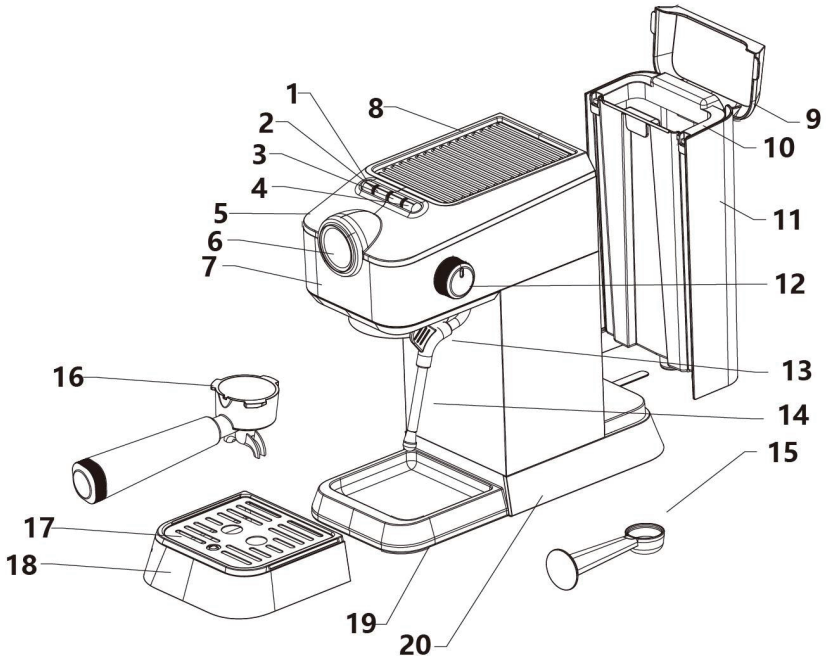

- 1. Steam indicator button
- 2. Double-cup indicator button
- 3. Single-cup indicator button
- 4. Power indicator button
- 5. Top cover
- 6. Pressure gauge
- 7. Top deco piece
- 8. Top cover deco piece

- 9. Tank cover
- 10. Tank handle
- 11. Water tank
- 12. Knob
- 13. Steam handle
- 14. Steam wand
- 15. Measuring spoon
- 16. Portafilter
- 17. Drip plate
- 18. Drip tray

- 19. Base
- 20. Base deco piece

BEFORE THE FIRST USE

To ensure the first cup of coffee tastes excellent, you should prep the coffee maker as follows:

1. Remove the plug at the bottom of the tank.
2. Fill the water tank. Do not exceed the " MAX " mark. Close the tank cover.
3. Place brewing filter without coffee grounds into filter holder.
4. Place cup/mug on drip plate. Make sure the knob is in the horizontal position (off-position).
5. Connect to power source, press " ON/OFF " . The power indicator will be illuminated and all indicators will momentarily flash.
6. The appliance will start heating, When the indicators stop flashing, it shows the preheating is finished. Press double-cup button " 2 CUP " , wait for a moment, The brewing will begin and water will flow out.
7. When the appliance stops pumping water automatically, the process is complete. Throw away the pumped out water.

NOTE:

There may be noise when pumping the water out the first time, it is normal, the appliance is releasing the air in the appliance. After about 20s, the noise will disappear.

MAKE ESPRESSO COFFEE

- 1.** Remove the portfilter by turning it clockwise, Add ground coffee to the brewing filter with a measuring spoon, a spoonful of ground coffee can make about one cup of top-grade coffee, then press the ground coffee powder tightly with the measuring spoon.
- 2.** Place brewing filter into filter holder, making sure it fits properly and then align the portfilter with the " LOCK " mark, and turn counter-clockwise to the " CLOSE " position.
- 3.** Place a cup on the drip plate.
- 4.** Select single- cup " 1 CUP " or double-cup " 2 CUP " . The brewing will begin in moments.
- 5.** The appliance will stop automatically once the brewing is done.

WARNING

Do not leave the coffee maker unattended during brewing.

- 6.** To remove the filter after brewing, turn portfilter clockwise.

MAKE HOT WATER

Place a cup or mug under the steam wand. Turn the knob to “/” position, and then the hot water will dispense from the steam wand. Turn knob to off when done.

FROTHING MILK/ MAKING CAPPUCCINO

You get a cup of cappuccino when you top a cup of espresso with frothing milk.

NOTE: When using the steamer, the portfilter must be assembled in position.

Before frothing milk, release steam for 10 seconds.

METHOD:

1. Press the “ STEAM ” button, the steam indicator will flash. When the steam indicator becomes solid, the preheating is finished.
2. Prepare espresso first.
3. Fill a jug with about 100 grams of milk for each cappuccino to be prepared, using cold whole milk is recommended.

NOTE:

A jug with a diameter not less than 70 ± 5 mm is recommended and bear in mind that the milk increases in volume by 2 times, make sure the height of the jug is enough.

4. Insert the steam wand into the milk about two centimetres, then turn the knob to the “” position, steam will come out from

the steam outlet. Froth milk by moving the jug up and down.

WARNING: Be sure to operate carefully. Steam may result in burns or injury.



5. Turn knob to off.

NOTE: Clean steam nozzle with wet sponge immediately after steam stops generating, but do so carefully!

6. Pour the frothed milk into the prepared espresso, now the cappuccino is ready. Sweeten to taste and if desired, sprinkle the froth with a little cocoa powder.

The steam wand can be used to froth milk, dispense hot water, or make hot chocolate.

NOTE: After making steam, you can press the " Single-cup " or " Double-cup " button immediately to brew coffee again.

The coffee indicator will flash quickly if the temperature is too high. If this happens, you need to turn the knob to " Hot water " setting "  /  ", and then the hot water will dispense. When the temperature goes down, the pump will stop automatically and you should turn the knob off, then you can brew coffee again.

If you do not want to brew coffee when the high-temperature warning occurs, you can press the " Single-cup " or " Double-cup " button again to cancel.

PROGRAMMING THE CUP SIZE

To make a single cup

Press the " Single-cup " button, the coffee starts to dispense and the " Single-cup indicator " flashes at the same time, when the desired amount is reached, press the " Single-cup " button again, the coffee stops dispensing. You have now programmed the coffee maker to understand what a single cup is and it will be saved for next time. The adjustable dispensing amount for a single cup ranges between 25ml and 60ml.

To make a double cup

Press the " Double-cup " button, the coffee starts to dispense and the " Double-cup indicator " flashes at the same time, when the desired amount is reached, press the " Double-cup " button again, the coffee stops dispensing. You have now programmed the coffee maker to understand what a double cup is and it will be saved for next time. The adjustable dispensing amount for a double cup ranges between 60ml and 100ml.

Restore factory setting

Simultaneously hold and press the " Single-cup " and " Double-cup " buttons for 3 seconds to restore to factory dispensing amounts.

AUTO SHUT OFF FUNCTION

If no operation is selected after 29 minutes of being powered on, the unit will power off automatically.

If no operation is selected after 215 ml of water are pumped out, the pump will stop automatically.

If no operation is selected after 180 seconds of frothing milk, the pump will stop automatically.

CLEANING AND MAINTENANCE

Turn knob to OFF and allow the coffee maker to cool down completely before cleaning.

Clean housing of coffee maker with moisture-proof sponge often and clean water tank, drip tray and drip plate regularly then dry them.

NOTE: Do not clean with alcohol or solvent cleanser. Never immerse the housing in water to clean.

Clean filter holder with cleanser or warm water.

Clean all the attachments and dry thoroughly.

CLEANING MINERAL DEPOSITS



1. To make sure your coffee maker operates efficiently, to clean the internal piping, and to preserve the flavor of your coffee, the coffee machine needs to be descaled, cleaned and maintained periodically. After 500 cycles, a descaling warning will be shown. All indicators will flash 5 times. It is time to descale. The descale warning will continue at start-up every time if you do not cancel it.
2. Fill the water tank with water and descaler to the MAX level (the scale of water and descaler is 4:1, Refer to the instructions on the descaler. Please use " household descaler " , You can also use citric acid instead of the descaler (the one hundred parts of water and three parts of citric acid).
3. Press " Double-cup " button once to start the brewing cycle. Dispense about 100ml of water. Then turn off the appliance and leave the descaling solution in the appliance for 5 minutes.
4. Turn on the appliance and repeat the previous step, 3 additional times.
5. Next, repeat this process using only clean TAP WATER 2 times (no descaler).
6. After you are finished, you need to cancel the descaling.

WARNING

Simultaneously press and hold the " Single-cup button " , " Double-cup button " and " Steam button " for 3 seconds.

TROUBLESHOOTING

PROBLEM	CAUSE	SOLUTION
Water leaks from the bottom of the coffee maker.	There is excess water in the drip tray.	Please empty the drip tray
	The coffee maker is malfunctioning.	Please contact an authorized service facility for repair.
Water leaks out of the side of the filter.	There is some coffee on filter edge.	Wipe filter down.
Coffee tastes like acid (vinegar).	Improper cleaning of mineral deposits.	Repeat the instructions in " before the first use " section several times.
	Ground coffee was stored in a hot, wet place for a long time.	Please use fresh coffee powder, or store unused coffee powder in a cool, dry place. After opening a package of coffee powder, reseal it tightly and store it in a refrigerator to maintain its freshness.
The coffee maker stopped working.	The power cord is not plugged in well.	Plug the power cord into a wall outlet correctly, if the appliance still does not work, please contact an authorized service facility for repair.
The frother does not work.	The white indicator is not illuminated.	The steam wand can be used to froth only when the white indicator is illuminated.

	The jug is too big or the shape is not suitable.	Use a tall and narrow jug
	You have used skimmed milk.	Use whole milk or half-skimmed milk.
Single-cup indicator and double-cup indicator blinking quickly.	The knob was not reset after dispensing hot water or cooling down.	Reset knob to off position.
Steam indicator blinking quickly.	The knob was not reset after 180s of making steam.	Reset knob to off position.
Single-cup indicator or double-cup indicator blinking quickly.	Boiler temp is too high.	Turn knob to  /  position, perform cooling operation.
Single-cup indicator , double-cup indicator and steam indicator blinking quickly.	The machine is turned on, but the knob was not reset.	Reset knob to " OFF " position.
ALL indicators flash at once, 5 times.	Need to remove mineral desposits.	Descale.

Do not take apart the appliance. Contact an authorized service facility.

Correct Disposal of this product



This marking indicates that this product should not be disposed with other household wastes throughout the EU. To prevent possible harm to the environment or humans from uncontrolled waste disposal, recycle it responsibly to promote the sustainable reuse of material resources. To return your used device, please use the return and collection systems or contact the retailer where the product was purchased. They can take this product for environmental safe recycling.



GRIMMEN



www.grimmenhome.com

